

### Application:

The SY actuators are NEMA 4, 4x rated and designed to meet the needs of HVAC and Commercial applications. Offered on the HSU and HS butterfly valve series, these actuators are available for on/off and modulating applications. Depending on the application, they are available in 24 VAC, 120 VAC and 230 VAC.

Technical Data	
Electrical Connection	½" conduit connector, screw terminals
Overload Protection	thermally protected 135°C cut-out
Motor Protection	H Class insulation (SY-1), F Class (SY-2...12)
Gear train	high alloy steel gear sets, self locking
Operating Range	(SY...-110) on/off, floating point (SY...120SR) 2-10 vdc (SY...120MFT) 2-10 vdc, 4-20mA, 0-10 VDC
Sensitivity	(SY...120SR/MFT) 0.4mA/200mV
Reversal Hysteresis	(SY...120SR/MFT) 1.0mA/500mV
Feedback	(SY...120SR/MFT) 2-10 vdc
Angle of Rotation	90°
Direction of Rotation	reversible
Position Indication	top mounted domed indicator
Internal Humidity Control	resistive heating element
Auxiliary Switches	(2) SPDT, 5A 250 VAC factory set for 5° and 85° change of state
Ambient Temperature	-22°F to +150°F [-30°C to +65°C]
Humidity Range	up to 95%
Housing Type	IP67, NEMA 4, 4X
Housing Material	die cast aluminum alloy
Agency Listings	ISO, CE, cCSAus

Power Supply 120 VAC 50/60Hz, single phase

Model	Torque	Speed 60Hz	Speed 50Hz	Power Consumption	Override	Weight
SY1-110(P)	35Nm/310 in-lbs	12s	13s	0.5A	8mm Wrench	2.0kg/4.9 lb.
SY2-120(SR/MFT)	90Nm/801 in-lbs	15s	17s	1.0A	Hand Wheel	11kg/24.5 lb.
SY3-120(SR/MFT)	150Nm/1335 in-lbs	22s	26s	1.0A	Hand Wheel	11kg/24.5 lb.
SY4-120(SR/MFT)	400Nm/3560 in-lbs	16s	18s	1.3A	Hand Wheel	22kg/48.5 lb.
SY5-120(SR/MFT)	500Nm/4450 in-lbs	22s	25s	1.5A	Hand Wheel	22kg/48.5 lb.
SY6-120(SR/MFT)	650Nm/5785 in-lbs	28s	31s	1.8A	Hand Wheel	22kg/48.5 lb.
SY7-120(SR/MFT)	1000Nm/8900 in-lbs	46s	55s	3.2A	Hand Wheel	36kg/79.5 lb.
SY8-120(SR/MFT)	1500Nm/13350 in-lbs	46s	55s	4.0A	Hand Wheel	36kg/79.5 lb.
SY9-120(SR/MFT)	2000Nm/17800 in-lbs	58s	70s	3.2A	Hand Wheel	56kg/123.5 lb.
SY10-120(SR/MFT)	2500Nm/22250 in-lbs	58s	70s	4.0A	Hand Wheel	56kg/123.5 lb.
SY11-120(SR/MFT)	3000Nm/26700 in-lbs	58s	70s	3.0A	Hand Wheel	56kg/123.5 lb.
SY12-120(SR/MFT)	3500Nm/31150 in-lbs	58s	70s	4.0A	Hand Wheel	56kg/123.5 lb.

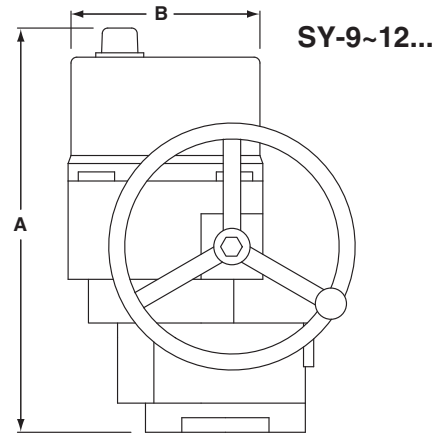
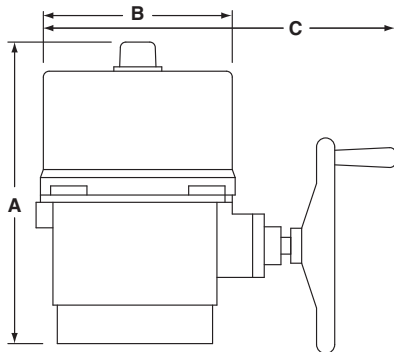
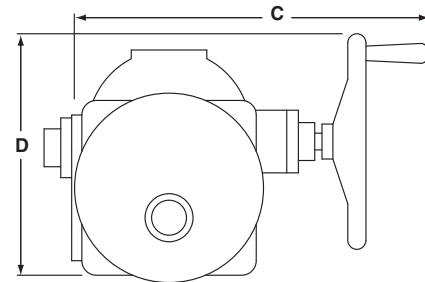
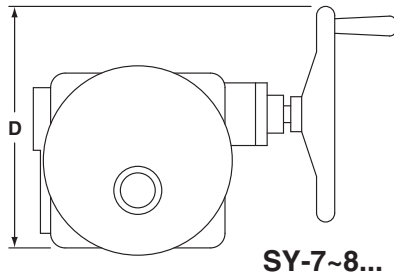
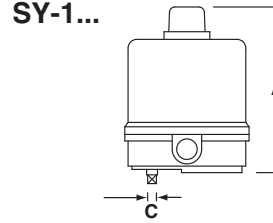
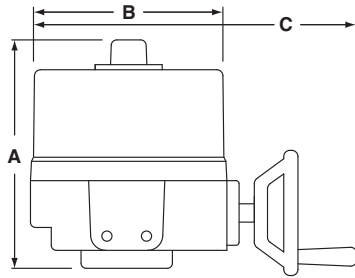
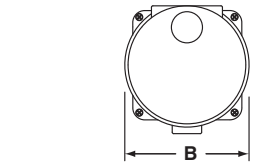
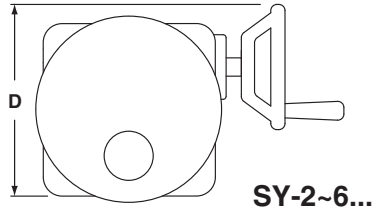

K20928 - 09/08 - Subject to change. © Belimo Aircontrols (USA), Inc.

MODEL	DIM A (MAX)	Add to Dim A for cover removal	DIM B	DIM C (MAX)	DIM D
	Inches [mm]	Inches [mm]	Inches [mm]	Inches [mm]	Inches [mm]
SY1	6.10 [155]	3.94 [100]	4.25 [108]	8mm	-
SY2~3	10.04 [255]	7.48 [190]	7.87 [200]	12.99 [330]	7.87 [200]
SY4~6	12.40 [315]	8.86 [225]	9.21 [234]	14.96 [380]	11.81 [300]
SY7~8	16.54 [420]	8.86 [225]	9.21 [234]	17.72 [450]	13.39 [340]
SY9~12	23.23 [590]	8.86 [225]	10.24 [260]	18.50 [470]	13.78 [350]

Note: ~ indicates range of actuator i.e., SY2~3 = SY-2 and SY-3